

NAME OF LEARNER:
NAAM VAN LEERDER:

CLASS:
KLAS:

**NATIONAL SENIOR CERTIFICATE
*NASIONALE SENIOR SERTIFIKAAT***

MATHEMATICS P2/*WISKUNDE V2*

GRADE/*GRAAD* 11

NOVEMBER 2018

**SPECIAL ANSWER BOOK
*SPESIALE ANTWOORDEBOEK***

QUESTION <i>VRAAG</i>	MARK <i>PUNT</i>			INITIAL <i>PARAAF</i>	MODERATION <i>MODERERING</i>			INITIAL <i>PARAAF</i>
1								
2								
3								
4								
5								
6								
7								
8								
9								
10								
11								
TOTAL <i>TOTAAL</i> (150)								

**This answer book consists of 24 pages.
*Hierdie antwoordeboek bestaan uit 24 bladsye.***



QUESTION/VRAAG 1

4	12	13	16	17	18	20	22	22	25
---	----	----	----	----	----	----	----	----	----

	<i>Solution/Oplissing</i>	Marks Punte
1.1		(1)
1.2		(2)
1.3		(1)
1.4		(3)
1.5		(3)
		[10]



QUESTION/VRAAG 2

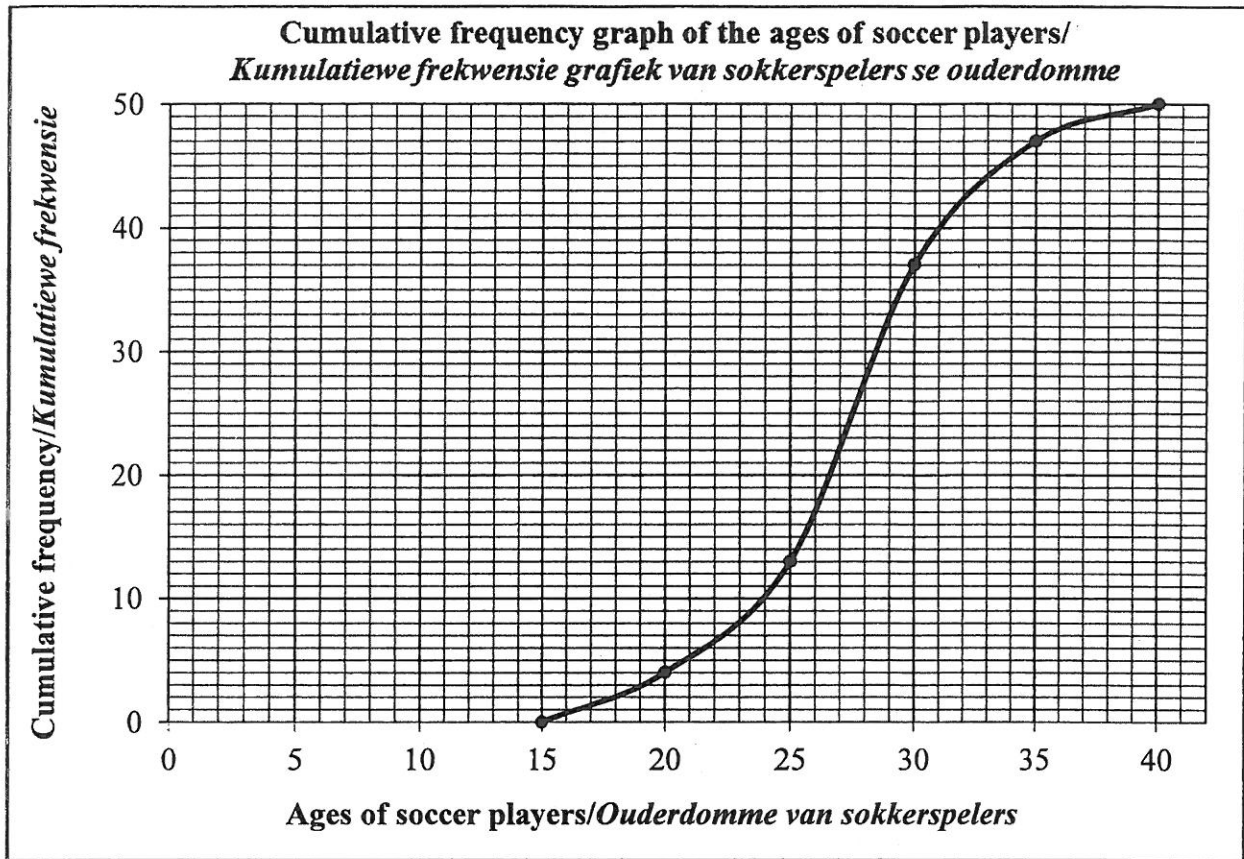

	Solution/Oplissing	Marks Punte
2.1.1		(1)
2.1.2		(2)



2.1.3

CLASS INTERVAL/ KLASINTERVAL	FREQUENCY/ FREKWENSIE	CUMULATIVE FREQUENCY/ KUMULATIEWE FREKWENSIE
$15 \leq x < 20$		4
$20 \leq x < 25$		13
$25 \leq x < 30$		37
$30 \leq x < 35$		47
$35 \leq x < 40$		50

(3)

2.1.4

Frequency polygon of the ages of soccer players/
Frekwensievelhoek van sokkerspelers se ouderdomme

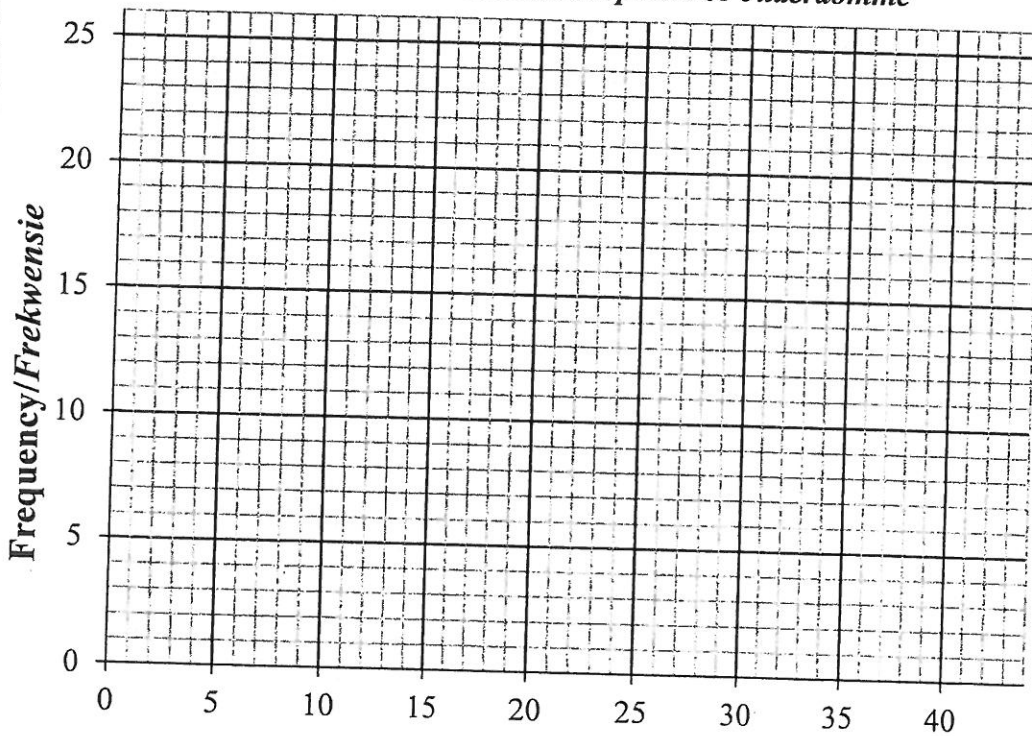

(4)

2.2

(3)

[13]



QUESTION/VRAAG 3

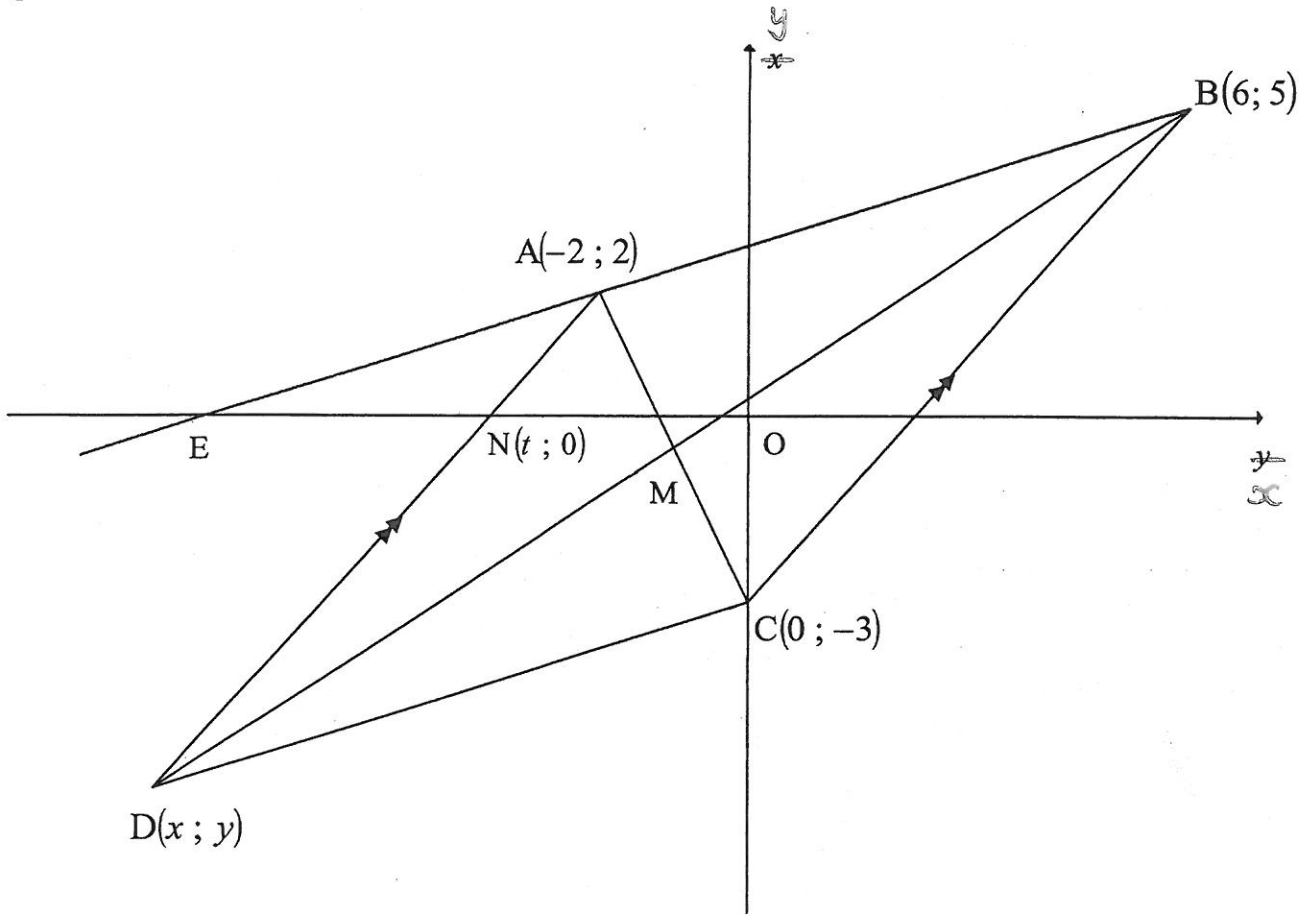

	Solution/Oplissing	Marks Punte
3.1		(2)
3.2		(3)



	Solution/Oplissing	Marks Punte
3.3		(2)
3.4		(2)
3.5		(4)
3.6		(3)
3.7		(3)
		(3)
		[19]



QUESTION/VRAAG 4

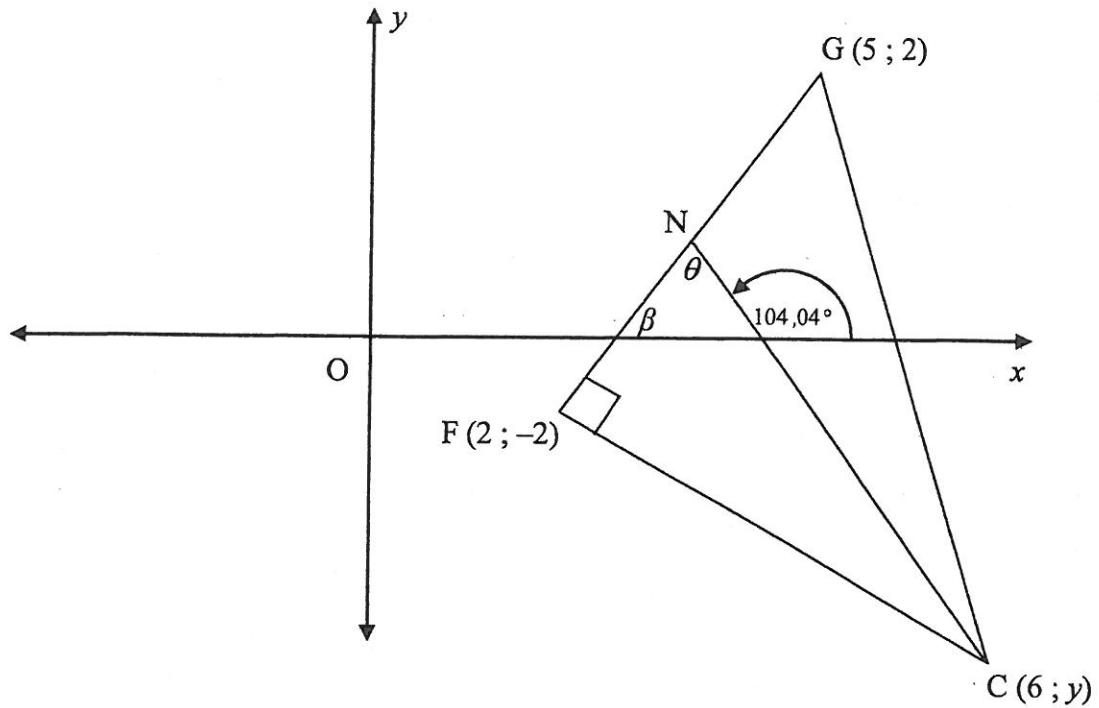

	Solution/Oplissing	Marks Punte
4.1		(2)
4.2		(3)



	Solution/Oplissing	Marks Punte
4.3		(3)
4.4		(4)
		[12]



QUESTION/VRAAG 5

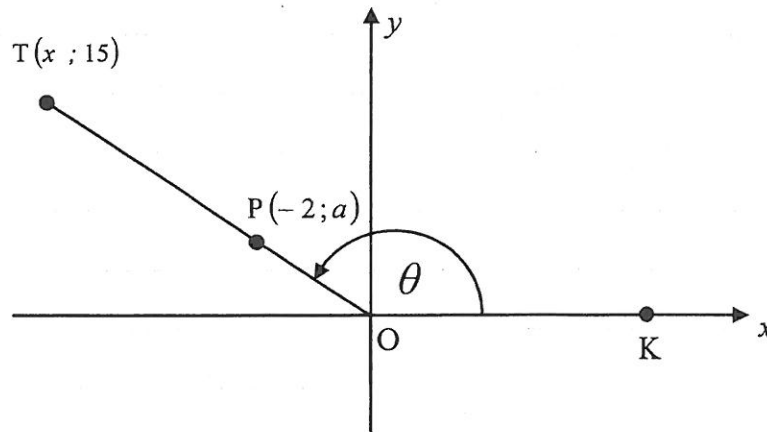

	Solution/Oplossing	Marks Punte
5.1.1		(2)
5.1.2		(1)
5.1.3		(2)
5.1.4		(2)



5.1.5		(3)
5.2		(7)
5.3		(5)



5.4		
	(6)	
	[28]	



QUESTION/VRAAG 6

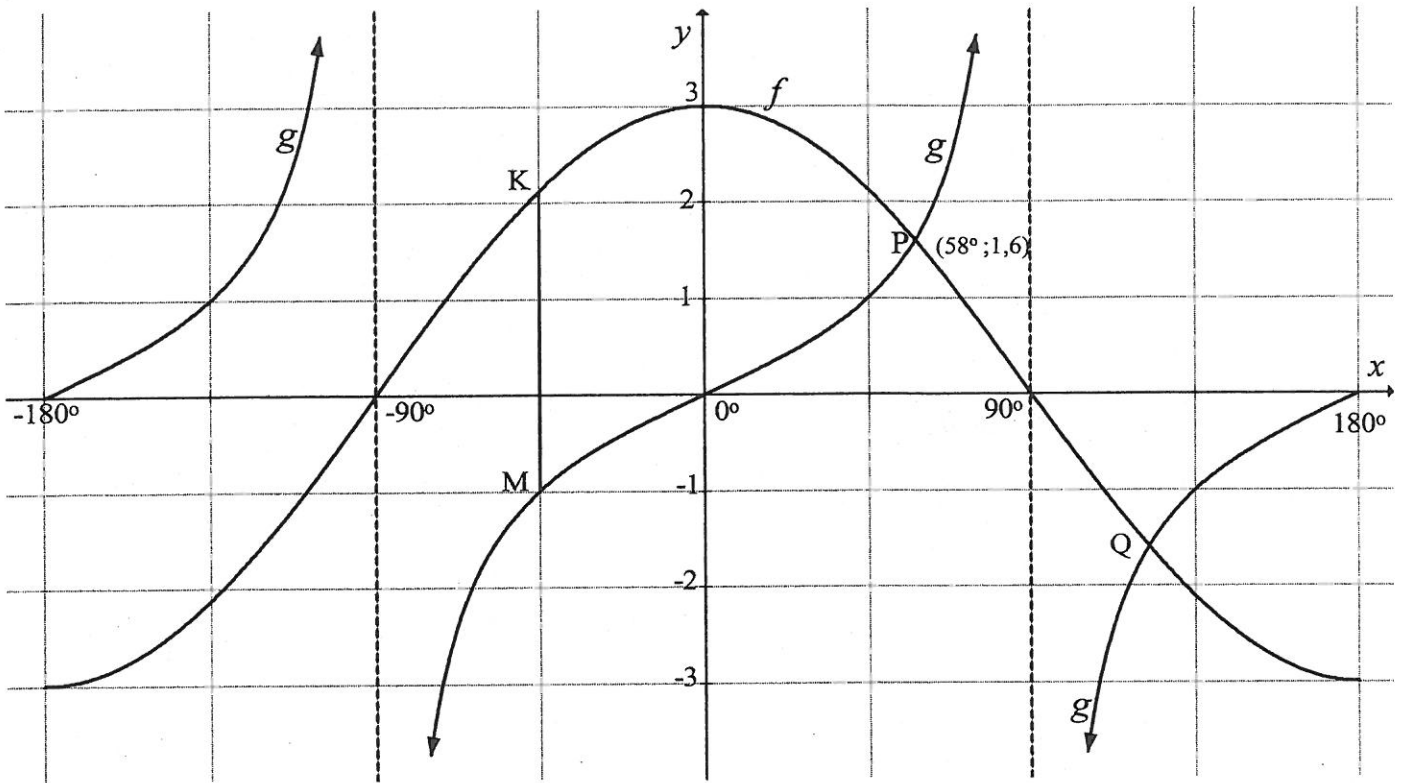

	Solution/Oplossing	Marks Punte
6.1		(2)
6.2		(1)
6.3		(2)
6.4		(2)
6.5		(2)
6.6		(2)
		[11]



QUESTION/VRAAG 7

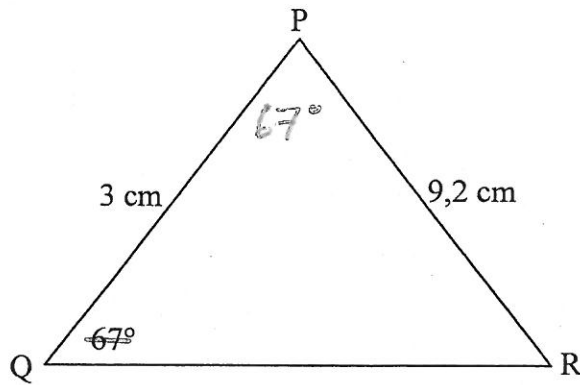

	Solution/Oplossing	Marks Punte
7.1		(3)



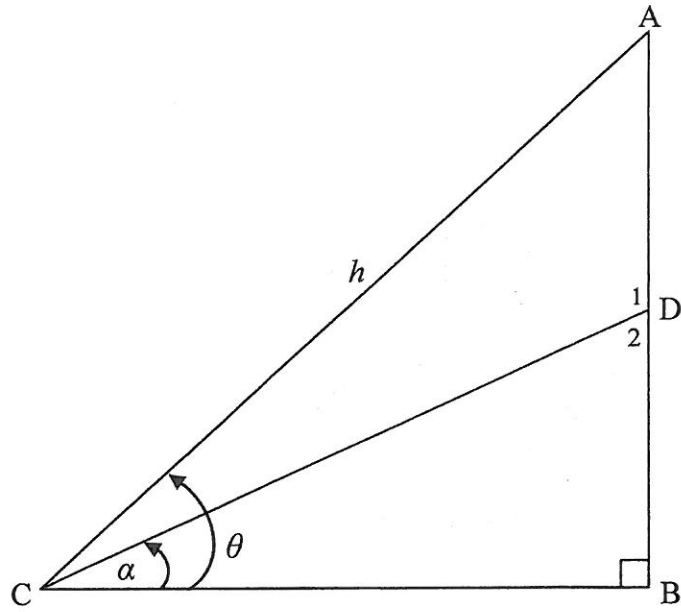

7.2.1		(1)
7.2.2		(4)
7.2.3		(2)
7.2.4		(3)
		[13]



QUESTION/VRAAG 8

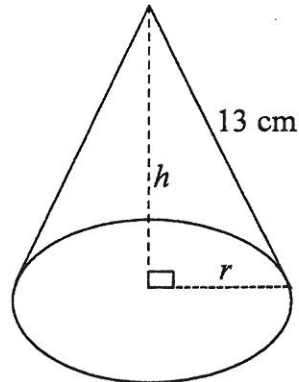

	Solution/Oplissing	Marks Punte
8.1		(4)
8.2		(3)
		[7]



Give reasons for your statements and calculations in QUESTIONS 9, 10 and 11.
 Gee redes vir jou bewerings en berekeninge in VRAAG 9, 10 en 11.

QUESTION/VRAAG 9

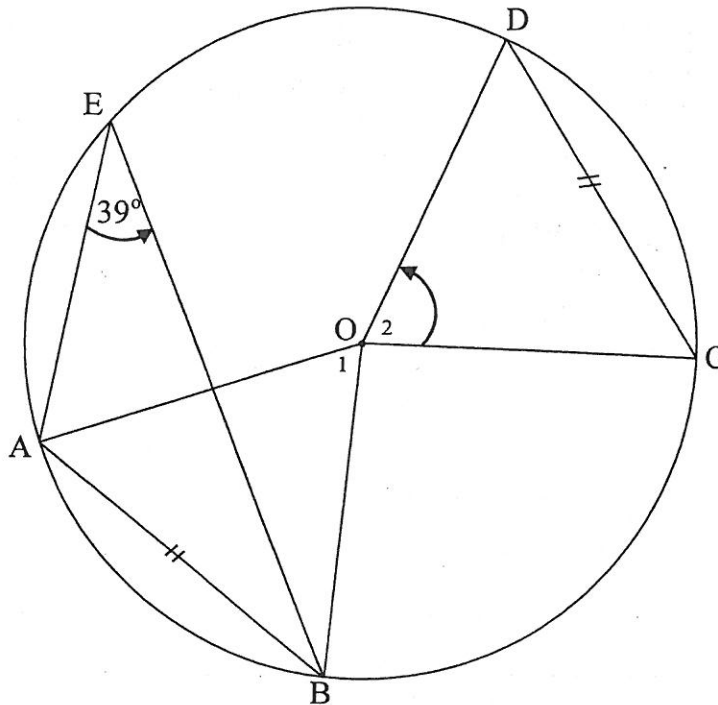

	Solution/Oplissing	Marks Punte
9.1.1		(2)
9.1.2		(2)



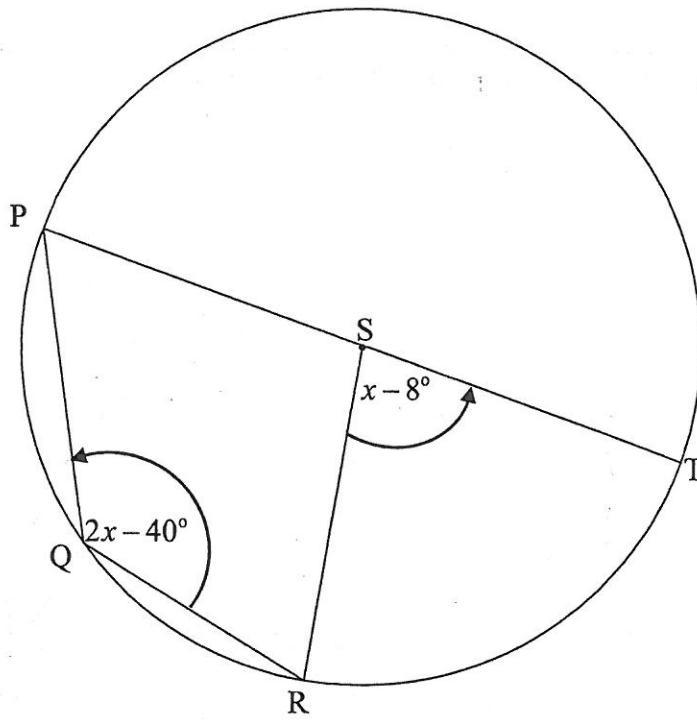

9.2

(4)



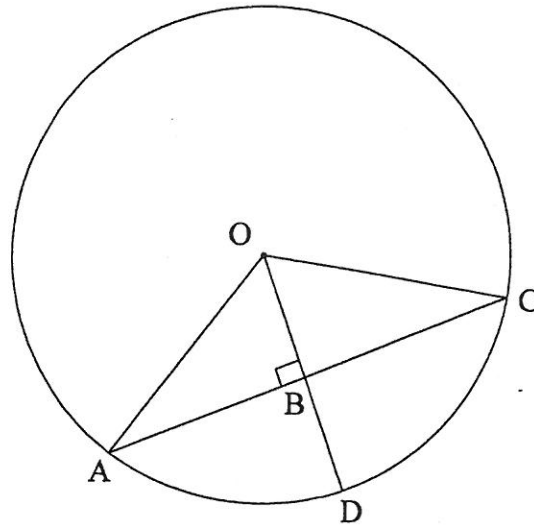

9.3		(5) [13]



QUESTION/VRAAG 10

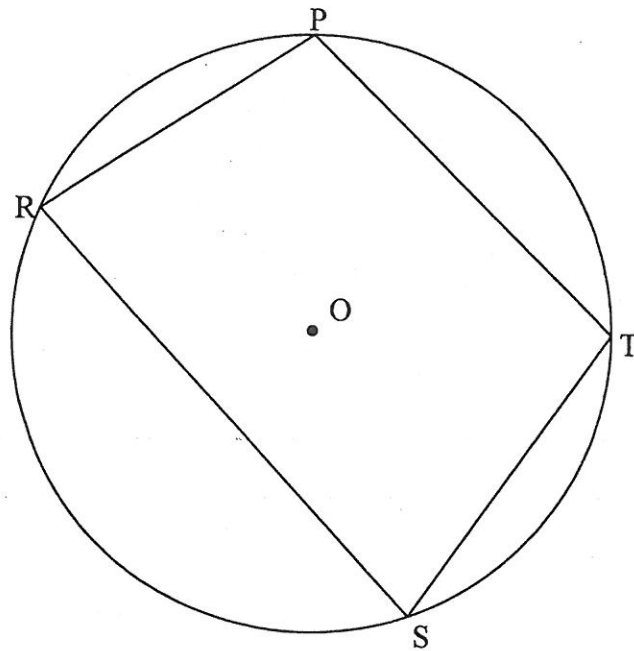

	Solution/Oplissing	Marks Punte
10.1		

(5)



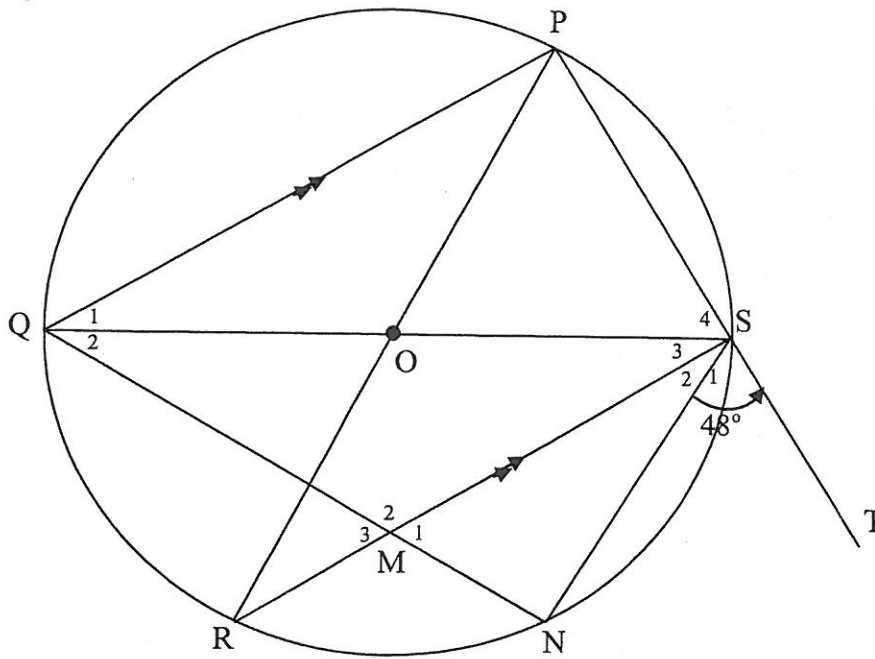

	Solution/Oplissing	Marks Punte
10.2.1(a)		(3)
10.2.1(b)		(2)
10.2.1(c)		(2)
10.2.2		(2)
		[14]



QUESTION/VRAAG 11

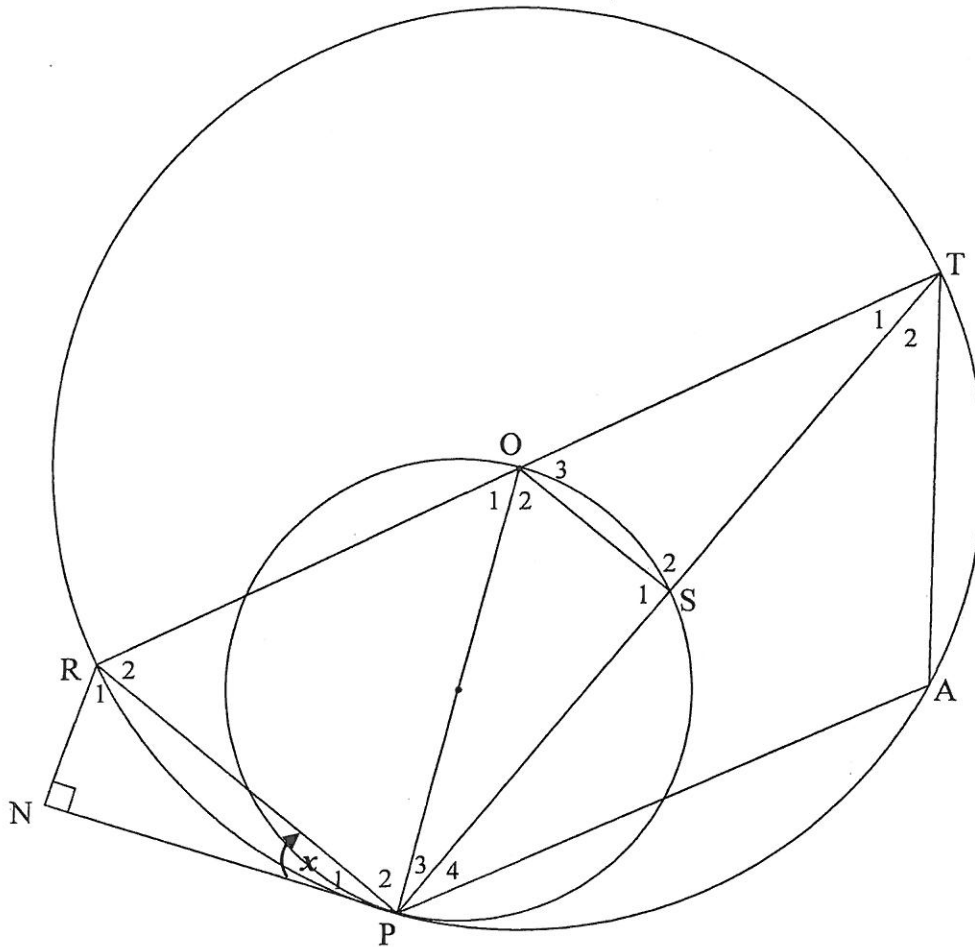

11.1		

(5)



11.2		
		(5)
	[10]	

TOTAL/TOTAAL: 150



